

SALTO
inspiredaccess



MIFARE

DESFire

LEGIC
advant innovation in ID technology



picopass®

XS4 WALL READER:

SALTO offers a wide range of wall readers that in combination with SALTO Door Controllers enable the expansion of SALTO access control benefits to all those doors where a stand alone electronic lock cannot be fitted i.e. barriers, elevators, mechanical doors etc, or where control must be boosted by on-line real-time access control. The wall readers read encrypted data contained on the carrier and communicate it to the door controller. They also allow for updating of the carrier via SALTO Virtual Network technology making it possible to cancel lost or stolen cards remotely.

Suitable for outdoor installation, the SALTO wall reader range also includes narrow profile wall readers that can be installed in the frame of a door. Some models are IP 65 compliant making them suitable for use indoors and out, including environments exposed to harsh weather conditions.

CONCEPTS:

Adaptable: Can be used for integration with other systems through the addition of the Wall reader Adapt or Control.

Secure: All communications between the carrier and the wall reader are encrypted and secured.

OPENING MODES:

- **Standard** (locked at all times)
- **Office** (free passage)
- **Timed Office** (automatic locking at end time)
- **Automatic opening** (8 pairs of "hands free" timed lock and unlocks per day with holidays)
- **Automatic Opening + Office** (just for R&W with CU2010)
- **Toggle** (present card to lock, present card to unlock) (just for R&W with CU2010)
- **Timed toggle** (automatic locking at end time) (just for R&W with CU2010)
- **Toggle + Automatic Opening** (just for R&W with CU2010)
- **Automatic changes** (just for R&W with CU2010)

ACCESS CONTROL FEATURES:

	Self programmable systems	ROM systems	RW systems
Maximum number of users per system:	1000	1000	64000
Maximum number of doors per system:	1000	64000	64000
Maximum events on lock audit:	-	1000	1000
Timezones:	-	30	256
Timeperiods:	-	20	256
Calendars in system:	-	4	256
Zones in system:	-	unlimited	unlimited
User groups:	-	unlimited	unlimited
Management:	Programming key and users key sets	Pro Access ROM software	Pro Access or HAMS software (available SQL versions)

ID TECHNOLOGIES:

SALTO XS4 Wall reader is available in different RFID technologies* (DESfire, DESfireEV1, Mifare, Mifare plus, Ultralight C, LEGIC advant, LEGIC prime, HID iCLASS®, Inside Picopass and SKIDATA allowing multi-application with third party systems using one card).

- 13.56MHz contactless RFID identification.
- Reusable key cards.
- SALTO Virtual Network (SVN) compatible².
- RFID RW technology, there's a contactless exchange of information between the card and the reader.
- High security encrypted Proximity cards.
- Multi-application with other systems using the same card through shared sectors.
- Customized card issuing through the SALTO Authentication Media software (SAM).
- Waterproof cards, which can be customized.
- Scalable: selfprogrammable, ROM, RW systems available using the same hardware.

MIFARE DESFIRE FEATURES:

Mifare RFID contactless technology reads and writes information to contactless smart cards (RFID) compatible with ISO 14443A, ISO 14443B and ISO 15693 standards, and as Mifare, Mifare plus, DESfire, DESfireEV1 technologies. They also allow for updating the carriers via SALTO Virtual Network (SVN) technology.

These SALTO electronic locks are compatible with NFC (Near Field Communication) technology, which allows NFC enabled cell phones to act as contactless data carriers to open and control SALTO access controlled doors.

- ISO 14443A, ISO 14443B and ISO 15693, Mifare, DESfire Compatible.
- Near Field Communication (NFC) compatible.
- Key card memories available: 1Kbyte, 4Kbytes and 8 Kbytes depending on technology.
- Key shape available: ISO 7810 Cards, fobs, bracelets, stickers, watches...

HID ICLASS FEATURES:

iCLASS® contactless technology from HID is RW identification technology based on 13.56 MHz read/write contactless smart card technology. iCLASS® offers enhanced security through encryption. This single-card, contactless solution permits multi-application with others systems, and with the SVN capabilities, you will acquire a lot of interesting new features for your property access control.

- ISO 14443B2 standard compliant.
- ISO 15693 standard compliant.

LEGIC FEATURES:

LEGIC Ident systems includes highly integrated LEGIC RF Standard and ISO 15693 and ISO 14443 compliant RW Chip Sets, Security Modules and Transponder Chips for integration into third party products. A very good option if you already use a LEGIC transponder system.

SALTO LEGIC electronic escutcheons are LEGIC Prime and advant compatible on the same device.

- Key card available: 256bytes (LEGIC Prime), 1024bytes (LEGIC Prime), 2Kbytes (LEGIC advant).
- Key shape available: ISO 7810 Cards, fobs, bracelets, stickers, watches...

PICOPASS FEATURES:

Picopass is a family of contactless memory chips that support both ISO14443B and ISO 15693 proximity and vicinity protocols. It allows for updating of carriers via SALTO Virtual Net (SVN) technology, is simple to use and offers a range of options including multiapplication with other systems using a picopass contactless card system.

- ISO 14443B proximity protocols for high speed communication range of 10 cm.
- ISO 15693 (Vicinity protocol) to operate at lower speeds over longer ranges.



Contact less key cards



Contact less fobs



Contact less bracelets



Contact less watches



NFC phones

Consult SALTO for carrier availability, not all the carriers are available for all the RFID Technologies above

MECHANICAL FEATURES:

- Body made of die cast Zinc Alloy.
- Reader made of stainless steel.
- Dimensions: 83mm x 83mm x 13.5mm (RFID Wall readers).
- Weight: 150 grams.
- Compatible with standard electrical back boxes for easy fitting.
- Reader equipped with a slot in order to drain water or other elements to avoid unsuitable performances of the device.
- Includes plastic covers to hide fixing screw.
- Built in heater for extreme weather conditions*.
- Waterproof gasket*

ELECTRONIC FEATURES:

- Read Only Memory (ROM) wall reader compatible with CUA010, CU1010 and CU2010 control unit.
- Read & Write (R&W) wall reader compatible with CU5000, CU50EN and/or CU50ENSV control unit.
- Off-line system (01 models).
- 5V supplied by the control unit.
- Red and Green coloured LED to indicate lock authorization.
- Can be used for integration with other systems through the addition of the Wall Reader Adaptor.

*depending on the model.

MODELS AVAILABLE:

Model WRMx000

- For on-line control units.

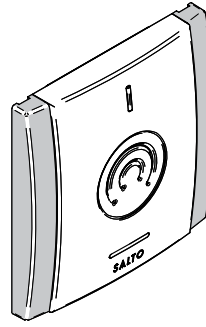

Model WRMx001

- For on-line control and off-line units.
- Includes PPD connector.

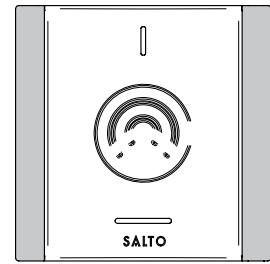
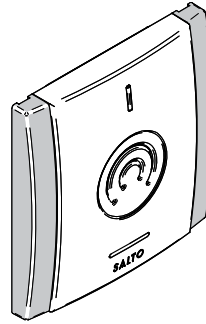

Model x000E

- For on-line control units.
- Equipped with a especial overhanging cap.

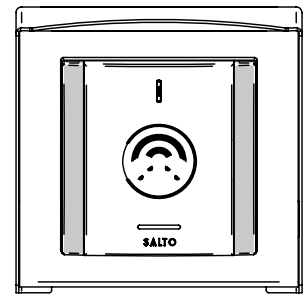
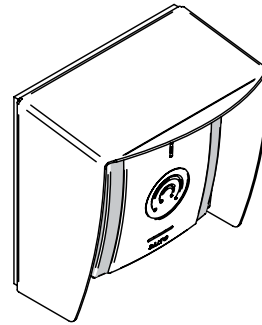

Model WRMx001E

- For on-line control and off-line units.
- Equipped with a especial overhanging cap.
- Includes PPD connector.

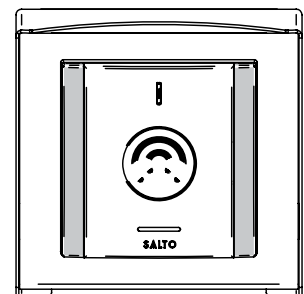
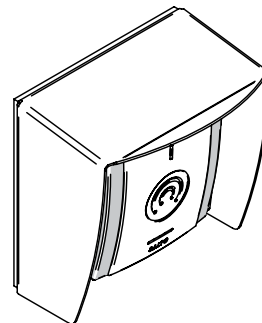

Model WRMx000EK

- For on-line control units
- Equipped with a especial overhanging cap
- Includes Keypad.

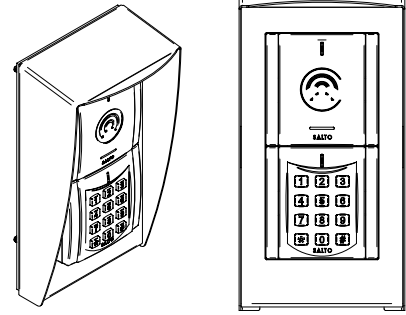

Model WRMx001EK

- For on-line control and off-line units
- Equipped with a especial overhanging cap
- Includes Keypad.
- Includes PPD connector.

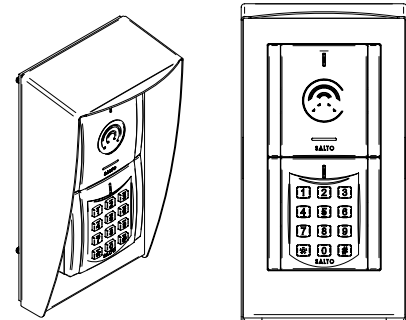

Model WRx001FS

- For narrow profile doors.



WRMKP PIN code pad

- Body made of die cast Zinc Alloy with Satin Chrome finishing.
- Keys made of AISI 316 L Stainless Steel.
- Size: 83mm x 83mm x 13.5mm.
- 5V supplied by the WRM.
- Connexion to the wall reader through a built in data cable.

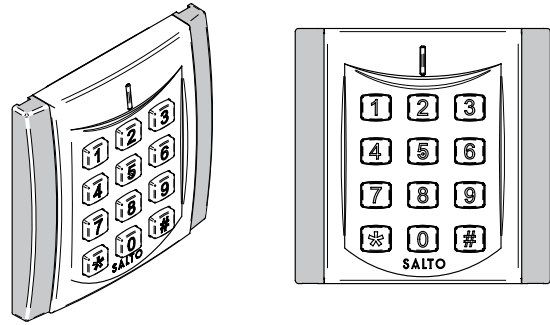

WRMFWAV vandal resistant frame

- Accessory designed to prevent damages to the WRM fixing points.
- Made of die cast Zinc Alloy with Satin Chrome finishing.
- Fastened with Torx 10 Anti Tamper Screws.
- To be fitted with WRMBLE (included with the WRMFWAV).

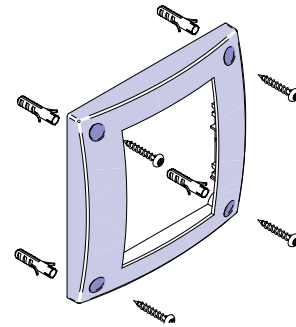

WRMFHAV vandal resistant frame

- Accessory designed to prevent damages to the WRM fixing points.
- Made of die cast Zinc Alloy with Satin Chrome finishing.
- Fastened with Torx 10 Anti Tamper Screws.
- To be fitted with WRMBH1 (included with the WRMFWAV).

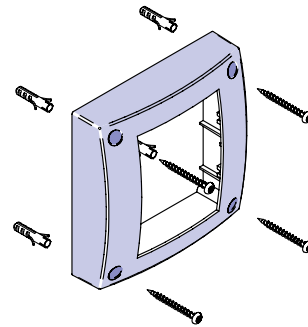

WRMBH1 single base for surface mounting

- Accessory designed for an easy surface mounting installation of the wall reader.
- Made of PC + ABS UL94 V0.
- Size 83mm x 83mm x 20mm.
- Includes a waterproof gasket.
- Can be used with the WRMFHAV.

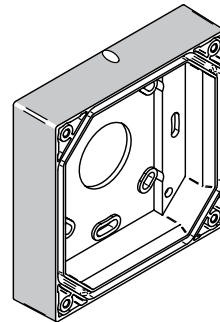

WRMBH2 double base for surface mounting

- Accessory designed for an easy surface mounting installation of the wall reader and a second accessory (WRMKP).
- Made of PC + ABS UL94 V0.
- Size 165mm x 83mm x 20mm.
- Includes a waterproof gasket.
- Can not be used with the WRMFHAV.

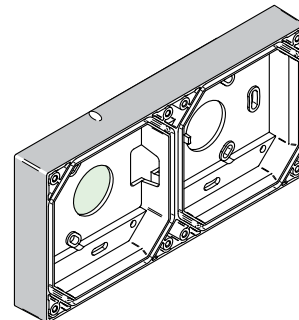

WRMBL1 single base for flush mounting

- Accessory design for an easy flush mounting installation of the wall reader.
- Made of PC + ABS UL94 V0.
- Size 83mm x 83mm x 20mm.
- Includes a waterproof gasket.
- Can be used with the WRMFWAV.

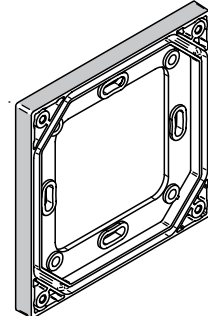

WRMBL2 double base for flush mounting

- Accessory designed for an easy surface mounting installation of the wall reader and a second accessory (WRMKP).
- Made of PC + ABS UL94 V0.
- Size 165mm x 83mm x 20mm.
- Includes a waterproof gasket.
- Can not be used with the WRMFWAV.

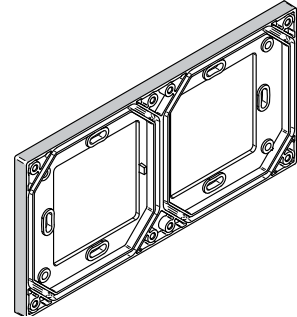

WRMFS concealed fixing cover for Modular wall readers

- Accessory designed to hide the screws of the wall reader.
- Made of PC + ABS UL94 V0.

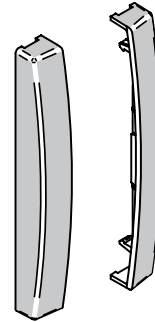

PLATFORM FEATURES:

- Completely integrated in the SALTO Systems platform.
- Enables users to have standalone electronic cylinders, standalone electronic locks, standalone electronic glass door locks (SALTO wireless compatible), emergency exit devices (SALTO wireless compatible), locker locks and IP based on-line readers, all in the same system with SALTO Virtual Network capabilities, making it possible to update user card access plans on the fly.



INSTALLATION

- Easy installation thanks to the SALTO bases (not included with the wall readers).
- Control unit connexion through a UTP CAT 5 cable.
- Max. distance from the wall reader to the control unit up to 100m (depending on the control unit and the number of readers).
- Fixing through Torx 10 anti tamperers.
- Off-line set up of the control unit through Portable Programmer Device.
- On-line set up of the control unit directly from the PC.

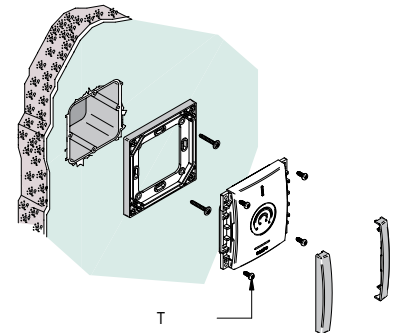

CERTIFICATIONS:

EN Certification:

- EN 300330-1 V1.3.2 (2002-12)
- EN 301 489-1 (2002)
- EN 301 489-3 (2002)
- EN 60950
- EN 55022 (1994), class B
- EN 55024 (1998)
- EN 61000-6-1 (2001)
- EN 61000-6-2 (2001)
- EN 61000-4-2 (1995)
- EN 61000-4-3 (1995)

OPERATING TEMPERATURES:

External escutcheon: -20°C / 70°C